

148-155 QUANTUM® 1.28

MANSFIELD®

Elongated Front, SmartHeight™, Vitreous China, Two-Piece Toilet

FEATURES

- High performance pressure-assist, high efficiency toilet (HET)
- 1.28 gpf / 4.8 lpf high efficiency water consumption
- Uses 20% less water than conventional toilets
- Elongated front, SmartHeight™ bowl
- 12" rough-in
- Model 45 chrome-plated, metal trip lever
- 2-1/8" glazed trapway
- The Mansfield® limited lifetime warranty on china, Flushmate ten-year limited warranty on vessel
- Available in White, Biscuit and Bone



MODEL 148-155

Toilet seat not included







ELONGATED



SMARTHEIGHT ADA

COMPONENTS

MODEL #	DESCRIPTION	CODES/STANDARDS
148-155	Elongated front, SmartHeight™ pressure-assist, two-piece toilet. Less toilet seat and supply. Specify color.	   
148	Elongated front, SmartHeight™ pressure-assist bowl only. Less toilet seat and supply. Specify color.	
155*	Pressure-assist tank and cover only with left hand chrome-plated, metal trip lever. Less supply. Specify color.	
TANK OPTIONS		
155RH*	Pressure-assist tank and cover only with right hand chrome-plated, metal trip lever. Less supply. Specify color.	
TANK TRIM & REPLACEMENT PARTS		
45	Trip lever - chrome-plated, metal trip lever, left hand	
125-LID	Tank lid	
FLUSHMATE® 503	Pressure-assist flushing system. Separate warranty applies. Contact FLUSHMATE® at 1-800-533-3460.	







*Tank models only

148-155 QUANTUM® 1.28



Elongated Front, SmartHeight™, Vitreous China, Two-Piece Toilet

SPECIFICATIONS

MODEL #	DESCRIPTION	CODES/STANDARDS
148-155	Elongated front, SmartHeight™ (1.28 gpf / 4.8 lpf) two-piece toilet	   

MATERIAL	Vitreous China
WATER PRESSURE RANGE	35 to 80 PSI
FLUSH SYSTEM	Flushmate™ flushing technology
WATER USAGE	1.28 gpf / 4.8 lpf
WATER SURFACE AREA	9-1/4" X 11-3/8"
ROUGH-IN	12"
MAP RATING	Pending

TRAP DIAMETER	2-1/8"
TRAP SEAL	3"
SHIPPING WEIGHT	Model 148 - 55 lbs. (25 kg) Model 155 - 41 lbs. (19 kg)
WARRANTY	Vitreous China - Limited Lifetime Vessel - Limited Ten Year (Flushmate)

TECHNICAL INFORMATION

Note: these dimensions are nominal and subject to change without notice.

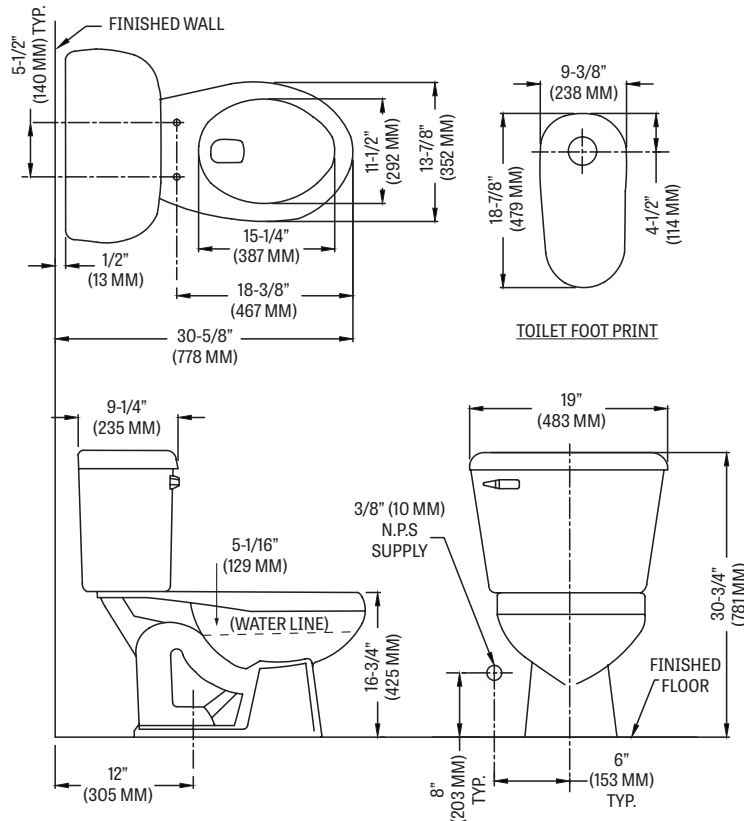

Fixture performance and specifications meet or exceed ASME A112.19.2/CSA B45.1 standards, and other state and local codes.



*Tank models only